

BLU-T SERIES

Battery Load Units

- Operating voltage range: **0,9 (0,0)* – 70,5 V DC**
*Total discharge down to 0 V available with ZVD module
- Lightweight – starting from 12,8 kg (28.2 lbs)
- Powerful – discharge power of up to **19,2 kW**
- Discharge current – up to **350 A DC**
- New 5,7 inch display
- New model: **BLU230T**
- Enables testing batteries while in service
- Detailed test analysis using DV-B Win software
- Test resume feature in case of interrupted power supply



Description

The Battery Load Units – BLU-T series are stand-alone or PC-controlled battery capacity test set, based on a state-of-the-art technology, using the most advanced power electronics solutions with coolers and fans integrated into device.

The BLU-T series devices provide the discharge current of up to 350 A and are applicable to up to 70.5 V battery voltages.

The BLU-T series devices are lightweight solutions developed to meet customer's wide ranging test procedures (standardized as well as customized). Using a BLU-T device, the capacity test is performed in an accurate, user-friendly way in accordance to actual standards for battery testing (IEEE 450-2010 / 1188-2005 / 1106-2015, IEC 60896-11/22 and other relevant standards).

Additionally, when combined with Zero Voltage Discharge Module ZVD, BLU-T enables **full battery discharge down to 0 V**, required before battery recycling.

Discharging can be performed at constant current, constant power, constant resistance or in accordance with a pre-selected load profile. The discharge test can be conducted even in case a battery remains connected to the load – by measuring and taking into account the load current during the process.

Values of voltage, current / power / resistance, capacity and elapsed time are displayed on touch screen display during the test. The instrument will keep the preset current / power / resistance constant during the test (no manual corrections during the test are required).

When a required discharge current or power exceeds the capacity of a single BLU-T device, several BLU220T and BLU230T models have the parallel mode feature. Alternatively, External Load Units BXL-T series can also be used to increase discharging capacity. Combined with Battery Voltage Supervisor BVS and Battery Voltage Recorders BVR, BLU-T series devices are powerful tool which enables performing comprehensive evaluation of batteries.

Overview of the maximum currents for various battery voltage ranges with the minimum achievable cell voltage of 1,75 V is presented in

the table below. Maximum currents available by using Extra Load unit BXL-T are also presented in the table.

| Battery voltage (V) | | Maximum current (A) | | | |
|--------------------------|-----------|---------------------|-----------|-----------|-----------|
| | | BLU110T | BLU220T | BLU230T | BXL-T |
| Nom. | Min / Max | | | | |
| 1,2 | 0,9 | 100 | - | - | - |
| | 1,5 | | | | |
| 2,0 | 1,85 | 100 | - | - | - |
| | 2,35 | | | | |
| 3,7 | 3,2 | 100 | - | - | - |
| | 4,2 | | | | |
| 6 | 5,55 | 100 | 100 | 280* | 62 |
| | 7,05 | | | | 80 |
| 12 | 11,1 | 150 | 200 | 280* | 125 |
| | 14,1 | | | | 165 |
| 24 | 22,2 | 150 | 350 | 280* | 250 |
| | 28,2 | | | | 330 |
| 48 | 44,4 | 150 | 350 | - | 241 |
| | 56,4 | | | | 320 |
| 60 | 55,5 | 120 | 270 | - | 189 |
| | 70,5 | | | | 250 |
| Weight (kg / lbs) | | 12,8 / 28.2 | 15,1 / 33 | 15,1 / 33 | 12,5 / 28 |
| Max Power (kW) | | 8,5 | 19,2 | 8,4 | 18 |

*BLU230T operating voltage range is 4,8 – 30 V.

New model BLU230T

New model, BLU230T is capable of testing the batteries within voltage range of 4,8 V – 30 V DC with a discharge current of up to 280 A DC throughout the entire defined voltage range. This model has all the features as the BLU220T (single mode, single & CP mode, profile modes as well as parallel mode), with the main difference of discharge current values in the above mentioned voltage range.

Application

Typical application is measuring the capacity and full voltage of the batteries that can be found in telecommunication systems. Additionally, BLU-T & ZVD system enables full discharge of the battery (down to 0 V DC). However, BLU-T units can be applied to any battery with voltage not exceeding 70,5 V DC which can be found in (but not limited to):

- Power plants
- Telecommunication systems
- Generator excitation systems
- Substations
- Protection and control systems

Connecting BLU-T to Battery

Single mode

The BLU-T device can be connected to any battery test object by using a set of current cables and, optionally, a set of voltage sense cables.

To maximize the accuracy and measurement repeatability, all clamps must have good connection to the battery terminals while any crossing between the cables should be avoided. The BLU-T displays an appropriate message if connection between a cable clamp and the corresponding battery terminal is not established.

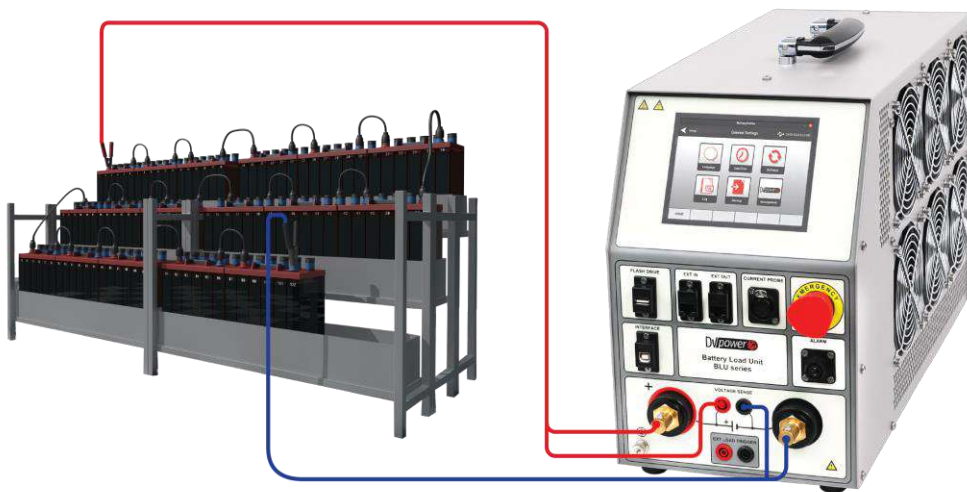

Parallel discharge test mode

In case the required discharge current or power exceeds the capacity of a single BLU-T device, several (up to ten) devices can be connected in parallel.*

Connection between BLU-T devices is established by using Ethernet ports and RS485 communication. The communication is based on a MASTER-SLAVE principle – arbitrary selected device is set as MASTER while all the other BLU-T devices should be set as SLAVE units. In the parallel connection the MASTER will discharge as much energy as possible; the remaining energy (discharge current / discharge power) will be discharged on the first SLAVE unit in a chain. If MASTER and the first SLAVE does not have capacity to cover the discharge requirements, the remaining energy will be discharged on the next SLAVE in a chain, etc.

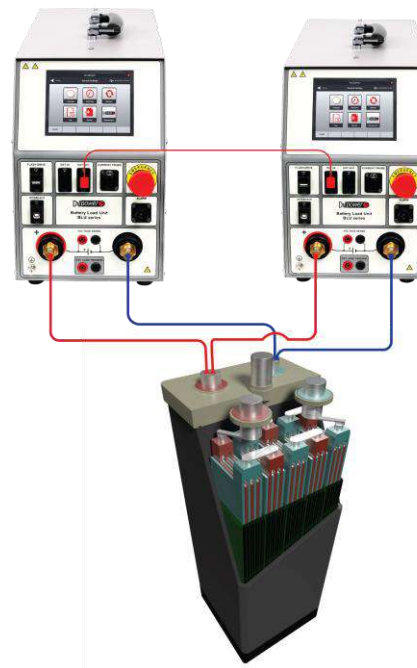

* BLU110T model do not support testing in parallel discharge mode.

Current Probe mode

In case the battery has to remain connected to the load, or an Extra Load BXL-T needs to be connected due to increase in discharge power, the discharge test needs to be carried out using the Current Probe CP MODE.

In this mode the measurement will be based either on the total battery current or a load current being measured by the DC current probe. The current probe connection point, for both modes, are illustrated in the figures below.

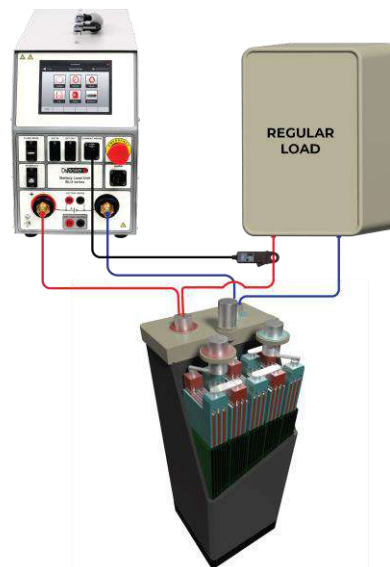
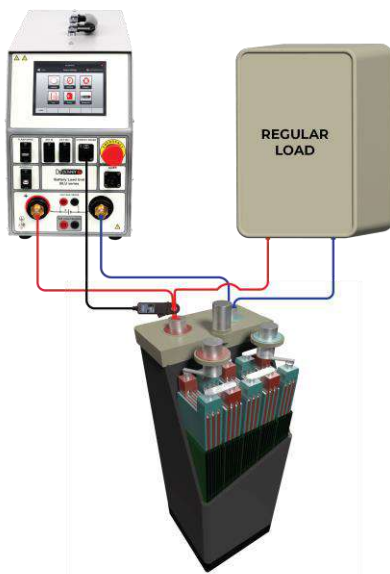

Benefits and Features

The list of the instruments application, benefits and features includes:

- Battery capacity measurement by conducting a discharge test, in compliance with corresponding IEEE, IEC and other relevant standards
- *Constant I*, *Constant P* and *Constant R* operation modes
- Several Load profile operation modes: *Load profile I*, *Load profile P* and *Load profile R*, enable simulating load characteristics variation during a discharge test
- Parallel operation feature (*not provided for BLU110T model*)
- Current probe mode enables conducting discharging test while a load remains connected or when BXL-T units or any other load units in the market are used
- Test settings can be modified during the test
- Discharge test of single Lead-acid, Li-ion cell and Ni-based cells
- Adjustable alarm and shutdown parameters for preventing excessive discharge
- Complete battery discharge (down to 0 V) when in system with Zero Voltage Discharge Module (ZVD)
- If supported by a Battery Voltage Supervisor BVS/BVS4 Series, additional features of cell voltage and cell temperature measurement are available.
- The total voltage and capacity curve, as well as numerical values are recorded in the unit's internal memory after a test. The results can easily be transferred to personal computer or laptop for storage, printout or export purposes.
- Using the DV-B Win software (on a personal computer or laptop), graphical (curves) and numerical values of current / power / resistance, capacity, voltage and elapsed time are displayed and can be observed in real-time.

1 - Display - 5.7" color touch screen display

2 - External input (EXT IN) and external output (EXT OUT) used for BLU-BLU parallel operation (*not available for BLU100A & BLU100L models*)

3 - Flash drive - used for transferring BLU memory data into an external memory stick + SBC / firmware upgrade

6 - Interface - enables controlling the BLU from a PC and downloading previously recorded results.

8 - Current and Voltage terminals - current and voltage test cable terminals

10 - Protective Earth Connector - protective earth connector used to connect to protective ground (PE)

4 - Current probe - measuring load current using the external current probe.

5 - Emergency STOP button - used when unexpected or unwanted action occurs.

7 - Alarm output - used for triggering external alarm buzzer.

9 - External Load trigger - used for triggering BXL external load units

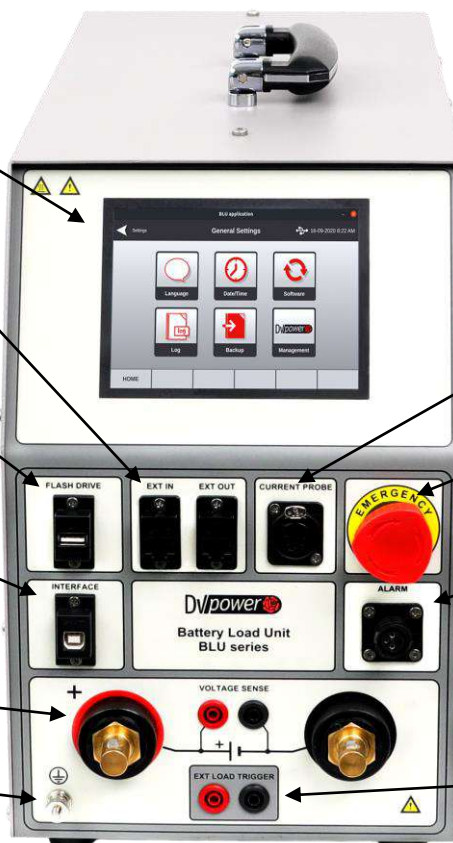

Combining BLU-T and BVR22

Battery Voltage Recorder Series BVR22 is a lightweight, user-friendly, rechargeable handheld device intended for individual battery cell voltage and temperature measurement while the battery is either in online or offline mode. When used in combination with the BLU-T device it serves as an efficient supplement to the battery capacity testing.

Options and features of the BVR22 model are presented in the table below.

| | |
|---|--|
|  | <p>Parameters Measured</p> <ul style="list-style-type: none"> - String and cell voltage, cell (electrolyte)/ambient temperature, DC current measurement using current clamps. - Simultaneous string voltage and DC current measurement - Bluetooth communication with external Density Meter <p>Measurement range</p> <ul style="list-style-type: none"> - String / Cell Voltage: ± 600 V DC - Current / Intercell voltage: ± 1 V DC <p>Data Transfer: Bluetooth and USB to PC</p> |
|---|--|

Combining BLU-T and BVS

DV Power battery voltage supervisor – BVS, is an accurate battery voltage monitoring system that monitors the state of health of battery systems. It records important battery parameters such as battery voltage, inter-cell connection voltage, and ambient temperature. Because of that, it can be a support tool for BLU-T during

capacity testing. There are two types of DV Power battery voltage supervisors:

- BVS – One cell voltage module measures 1 cell
- BVS-4 – One cell voltage module measures 4 cells

| Series | BVS | BVS-4 |
|-------------------------------|---|---|
| Picture |  |  |
| No. of Measured Cells | One module measures one cell | One module measures four cells |
| Inter-cell Connection Voltage | ✓ | ✗ |
| Cell Temperature | YES (one temperature channel per cell) | YES (one temperature channel per 4 cells) |
| Ambient Temperature | ✓ | ✓ |

Combining BLU-T and ZVD

Zero Voltage Discharge Module ZVD Series is specially designed external module enabling full battery discharge (down to 0 V). It is designed to operate in a system with BLU-T providing total discharge of batteries with voltage up to 70,5 V DC (up to 500V when used with BLU-A and 800V when used with BLU-C series). The total battery discharge is required in the battery recycling process. It is important to discharge a battery completely before entering the recycling process, because the battery can contain some remanent energy. That remanent energy can be dangerous and create problems during the disassembling of a battery or even during its transportation. In order to prevent that, we created the ZVD Series enabling a full

battery discharge. A single discharge down to 0 V will not extract all the energy from the battery. Once the discharge is finished, battery voltage will rise to some non-zero value, confirming there is still energy in the battery. The phenomenon is called the battery voltage rebound. BLU-T & ZVD system improves the

discharge process by discharging the battery in 2 steps:

Step 1: Efficient (up to 60 A) and controlled (current is constant down till 0 V is reached) discharge until battery voltage drops to 0 V.

Step 2: ZVD short-circuits the battery to remove the remaining energy.

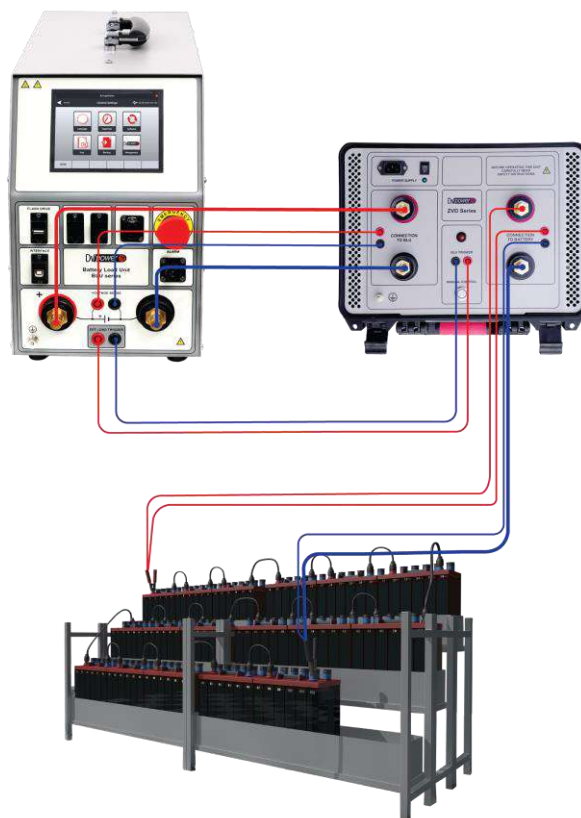

DV-B Win Software

The DV-B Win software is included in the purchase price, and all its updates are free of charge. Using the DV-B Win software a test can be controlled, performed and observed from a PC (or notebook), and the results can be saved directly on a PC (or notebook). Communication between the BLU-T and a PC (or notebook) is achieved through a USB cable. Using DV-B Win the results can be arranged and printed for a report in a selectable format as an XLS, PDF,

Word, or RTF format. Also, the possibility of importing other types of data format (jpg, png, doc) into standardized DV-B Win report is provided, as well as exporting the numerical and graphical results from DV-B Win into customizable report. Additionally, the software provides a possibility of setting extra parameters (cell voltage, string voltage, capacity and time) for alarming and ending the test.

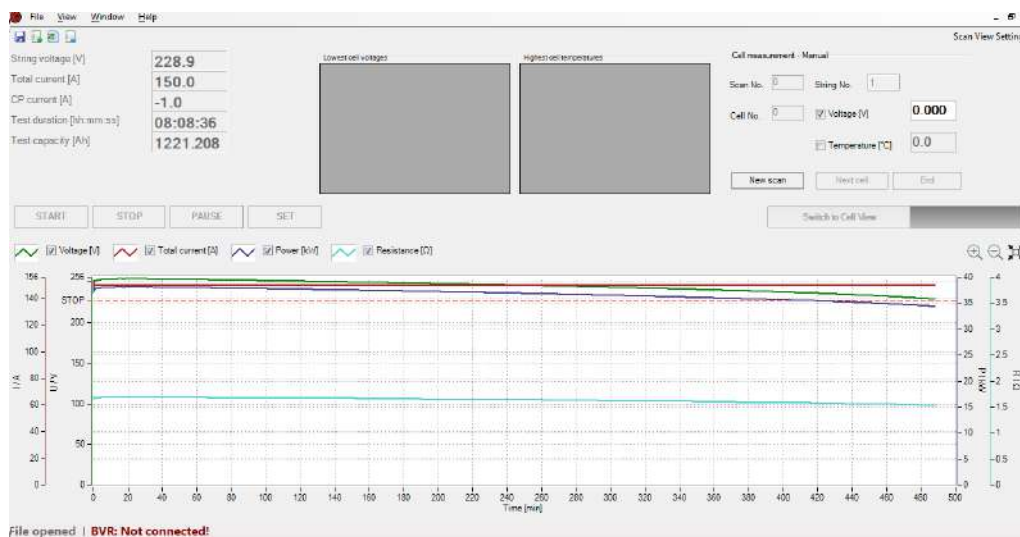

Technical Data

Mains Power Supply

- Connection according to IEC/EN60320-1; C320 90 V – 264 V AC, 50 / 60 Hz, single-phase
* Optionally / provided on request

Dimensions and Weights

| Model | | Dimensions | Weight |
|---------------------------|------------------|---|----------------------|
| BLU110T (without acc.) | Instrument | 440 x 221 x 355 mm 17.3 x 8.7 x 14 in | 12,8 kg 28.2 lbs. |
| | Transport case * | 545 x 300 x 418 mm 21.1 x 11.8 x 16.5 in | 6,9 kg 15.2 lbs. |
| BLU220T (without acc.) | Instrument | 560 x 221 x 355 mm 22 x 8.7 x 14 in | 15,1 kg 33.2 lbs. |
| | Transport case * | 665 x 300 x 418 mm 26.2 x 11.8 x 16.5 in | 8,5 kg 18.7 lbs. |
| BLU230T (without acc.) | Instrument | 560 x 221 x 355 mm 22 x 8.7 x 14 in | 15,1 kg 33.2 lbs. |
| | Transport case * | 665 x 300 x 418 mm 26.2 x 11.8 x 16.5 in | 8,5 kg 18.7 lbs. |

* Included instrument transport case

Measurement

Internal voltage measurement

| Model | Range ** | Resolution |
|---------|-------------|-----------------------|
| BLU110T | 0 – 75 V DC | 0,1 V (or better*) |
| BLU220T | 0 – 75 V DC | 0,1 V (or better*) |
| BLU230T | 0 – 30 V DC | 0,1 V (or better*) |

* Optionally / provided on request

** Range is set automatically at start of test

- Typical accuracy: $\pm 0,5\%$ of reading $\pm 0,1$ V

Internal current measurement

| Model | Range | Resolution |
|---------|--------------|------------|
| BLU110T | 0 – 300 A DC | 0,1 A |
| BLU220T | 0 – 400 A DC | 0,1 A |
| BLU230T | 0 – 400 A DC | 0,1 A |

- Display range: 0 – 2 999,9 A DC
- Basic accuracy: $\pm (0,5\% \text{ of reading} + 0,1 \text{ A})$
- Resolution: 0,1 A

Time measurement

- Typical accuracy: $\pm 0,1\%$ of reading ± 1 digit

Input for current probe

- Range: 0 – 1 V DC
- mV/A ratio: Software settable values: 0,3 to 100 mV/A
- Input impedance: $> 1 \text{ M}\Omega$

Load section

| Model | Battery Voltage |
|---------|-------------------|
| BLU110T | 0,9* – 70,5 V DC |
| BLU220T | 5,55* – 70,5 V DC |
| BLU230T | 4.8* – 30 V DC |

*Total discharge down to 0 V available with ZVD module

- Power: 19.2 kW (max)
- Discharge modes:
Constant current / power / resistance;
current, power or resistance profile mode

Constant current (Const I)

| Model | Range |
|------------|---------------|
| BLU110T | 0 – 150 A DC* |
| BLU220T | 0 – 340 A DC* |
| BLU230T | 0 – 280 A DC* |
| ZVD module | 0 – 60 A DC |

* Range of currents settable on a single unit

- Typical accuracy: $\pm (0,5\% \text{ of reading} + 0,2 \text{ A})$
- Ripple: max 0,4 A peak
- Resolution: 0,1 A

Constant resistance (Const R)

| Model | Resistance |
|---------|----------------------|
| BLU110T | 0,01 – 70,5 Ω |
| BLU220T | 0,2 – 70,5 Ω |
| BLU230T | 0,2 – 30 Ω |

* Optionally / provided on request

- Typical accuracy: $\pm 1\%$
- Resolution: up to 0,01 Ω

Constant power (Const P)

| Model | Range | Resolution |
|---------|--------------|------------|
| BLU110T | 0 – 8,5 kW* | 0,01 kW |
| BLU220T | 0 – 19,2 kW* | 0,01 kW |
| BLU230T | 0 – 8,4 kW* | 0,01 kW |

- Typical accuracy: $\pm 1\%$
- Ripple: max 0,2 kW

* Discharge power range settable on a single unit

Display Size

- 5,7 inch color touch screen display

Range / Resolution

- Current: 0 – 2 999,9 A DC / 0,1 A
- Voltage: 0 – 999,9 V DC / 0,1 V
- Capacity: 0 – 9999,9999 Ah / 0,0001 Ah
- Time: 00h:00m:00s - 23h:59m:59s / 1 sec

STOP parameters

- End voltage (total battery or per-cell voltage)
- Capacity
- Test time

Environment conditions

- Operating temperature: -20 °C to +55 °C / -4 °F to +131 °F
- Storage & Transportation temperature: -40 °C to +70 °C / -40 °F to +158 °F
- Relative humidity: up to 95%, non-condensing
- Pollution degree: 2

Shock/Vibration/Fall

- Instrument: ETSI EN 300 019-2-7 class 7M2
- Instrument in transport case: ISTA 2A

Communication with PC

- USB
- RS232 (optional)
- Ethernet (optional)

Protection

- Thermal cut-outs and automatic overload protection
- Emergency Stop button
- Overcurrent, overheat and overvoltage protection

Available languages

- English, German, French, Spanish

Current probe specifications

| Current probe | Ranges | mV/A – ratio | Supply |
|-------------------------|--------|--------------|---------------------|
| Current clamp 30/300 A* | 30 A | 10 mV / A | From the instrument |
| | 300 A | 1 mV / A | |

* current clamps 100/600 A and/or 200/1000 A can be provided on request.

Encapsulation class / Ingress protections

- IP20

Warranty

- 3 years + additional 1 (one) year upon registration on DV Power official website (www.dv-power.com)

Applicable Standards

- IEEE 450-2010, IEEE 1188-2005, IEEE 1106-2015, IEC 60896-11, IEC 60896-22 and other relevant standards
- Safety
 - Low Voltage Directive: Directive 2014/35/EU (CE conform) Applicable standards, for a class I instrument, pollution degree 2, Installation category II: IEC EN 61010-1
- Electromagnetic Compatibility:
 - Directive 2014/30/EU (CE conform) Applicable standard: EN 61326-1
- CAN/CSA-C22.2 No. 61010-1

All specifications herein are valid at ambient temperature of + 25 °C /+ 77°F and standard accessories. Specifications are subject to change without notice.

Accessories



Current cables



Extension cables



Sense cables with dolphin clips



Transport case



ZVD Module



Current clamp 30/300 A



Cable bag



Cable set for BLU-BXL simultaneous triggering



Cable for BLU-BLU parallel operation



Cable for external alarm

Order Info

| Instrument | Article No |
|---------------------------|--------------|
| Battery Load Unit BLU110T | BLU110T-D-00 |
| Battery Load Unit BLU220T | BLU220T-D-00 |
| Battery Load Unit BLU230T | BLU230T-D-00 |

| Included Accessories | Article No |
|---|--------------|
| Windows based DV-B Win PC software including USB cable | |
| Mains Power cable | MPCXXA-XX-00 |
| Ground (PE) cable | CABLE-GND-00 |
| Transport case for BLU - small size (<i>for BLU110T model</i>) | HARD-CASE-B0 |
| Transport case for BLU – medium size (<i>for BLU220T model</i>) | HARD-CASE-BL |

| Standard | Article No |
|--|--------------|
| Current cables 2 x 3 m 50 mm ² (9.84 ft, 0 AWG) with alligator clamps (A4) isolated (<i>for BLU110T</i>) | C2-03-50FA4I |
| Current cables 2 x 3 m 70 mm ² (9.84 ft, 00 AWG) with alligator clamps (A4) isolated (<i>for BLU220T & BLU230T</i>) | C2-03-70FA4I |
| Sense cables 2 x 3 m (9.84 ft) with banana plugs + dolphin clip | S2-03-00BPDC |
| Cable bag | CABLE-BAG-00 |

| Optional | Article No |
|---|--------------|
| Zero Voltage Discharge Module ZVD | BLU-ZVDMxx-0 |
| Battery External Load Unit BXL-T | BXL400X-T-00 |
| Battery Voltage recorder BVR22 with accessories | BVR22X-NN-00 |
| Cable set 2 x 2 m 1 mm ² (6.56 ft, 17 AWG) for BLU-BXL simultaneous triggering (<i>for BXL-T model</i>) | PO-02-01BPBP |
| Cable set 2 x 5 m 1 mm ² (16.4 ft, 17 AWG) for BLU-BXL simultaneous triggering (<i>for BXL-T model</i>) | PO-05-01BPBP |
| Current cables 2 x 5 m 70 mm ² (16.4 ft, 00 AWG) with alligator clamps (A4) isolated (<i>for BLU220T and BXL-T models</i>) | C2-05-70FA4I |
| Current cables 2 x 5 m 25 mm ² (16.4 ft, 3 AWG) with alligator clamps (A4) isolated (<i>for BLU110T model</i>) | C2-05-25FA4I |
| Extension cables 2 x 5 m 70 mm ² (16.4 ft, 00 AWG) (<i>for BLU220T and BXL-T models</i>) | E2-05-70VFMI |
| Extension cables 2 x 3 m 16 mm ² (9.84 ft, 5 AWG) with alligator clamps (A4) isolated (<i>for BLU110T model</i>) | E2-03-16VFMI |
| Sense cables 2 x 5 m (16.4 ft) with banana plugs + dolphin clip (<i>for BLU-T models</i>) | S2-05-00BPDC |
| Current clamp 30/300 A power supplied from the instrument with extension 5 m (16.4 ft) (<i>for BLU-T models</i>) | CACL-0300-06 |
| Cable for external alarm (<i>for BLU-T models</i>) | CABLE-EXA-05 |
| Extension cable for external alarm 5 m (16.4 ft) (<i>for BLU-T models</i>) | E1-EXABLU-05 |
| Cable for BLU-BLU parallel operation 3 m (9.84 ft) (<i>for BLU220T & BLU230T model</i>) | CP-03RJ45-00 |

Order Examples

BLU110T with standard accessories

| Instrument with Included Accessories | Quantity | Article No |
|--|----------|--------------|
| Battery Load Unit BLU110T | 1 set | BLU110T-D-00 |
| - Mains power cable | | |
| - USB with DV-B Win PC software | | |
| - USB cable | | |
| - Ground (PE) cable | | |
| - Transport case | | |
| Standard Accessories | | |
| Current cables 2 x 3 m 50 mm ² (9.84 ft, 0 AWG) with alligator clamps (A4) isolated | 1 set | C2-03-50FA4I |
| Sense cables 2 x 3 m (9.84 ft) with banana plugs + dolphin clip | 1 set | S2-03-00BPDC |
| Cable bag | 1 pc | CABLE-BAG-00 |

BLU220T with standard accessories

| Instrument with Included Accessories | Quantity | Article No |
|---|----------|--------------|
| Battery Load Unit BLU220T | 1 set | BLU220T-D-00 |
| - Mains power cable | | |
| - USB with DV-B Win PC software | | |
| - USB cable | | |
| - Ground (PE) cable | | |
| - Transport case | | |
| Standard Accessories | | |
| Current cables 2 x 3 m 70 mm ² (9.84 ft, 00 AWG) with alligator clamps (A4) isolated | 1 set | C2-03-70FA4I |
| Sense cables 2 x 3 m (9.84 ft) with banana plugs + dolphin clip | 1 set | S2-03-00BPDC |
| Cable bag | 1 pc | CABLE-BAG-00 |